

SHARP

SPEC. No. DG-07Z003

ISSUE Dec. 4th, 2007

COMPOUND SEMICONDUCTOR SYSTEMS DIVISION

ELECTRONIC COMPONENTS (ELECOM) GROUP

SHARP CORPORATION

SPECIFICATIONS

REFERENCE

DEVICE SPECIFICATION FOR

LIGHT EMITTING DIODE

MODEL No.

GM5WA94310A

CUSTOMERS' APPROVAL

Date _____

By _____

PRESENTED

Date *Dec. 20. 07*

By *S. Yokota*

S. Yokota
Department General Manager
LED Business Development Center
Compound Semiconductor Systems Division
Electronic Components (ELECOM) Group
SHARP CORPORATION

REFERENCE

PRODUCT NAME

Chip LED

MODEL No.

GM5WA94310A

1. These specification sheets include materials protected under the copyright of Sharp Corporation ("Sharp"). Please do not reproduce or cause anyone to reproduce them without Sharp's consent.
2. When using this product, please observe the absolute maximum ratings and the instructions for use outlined in these specification sheets, as well as the precautions mentioned below. Sharp assumes no responsibility for any damage resulting from use of the product which does not comply with the absolute maximum ratings and the instructions included in these specification sheets, and the precautions mentioned below.

(Precautions)

- (1) This products is designed for use in the following application areas;

<ul style="list-style-type: none"> * OA equipment * Telecommunication equipment (Terminal) * Tooling machines 	<ul style="list-style-type: none"> * Audio visual equipment * Measuring equipment * Computers 	
--	--	--

If the use of the product in the above application areas is for equipment listed in paragraphs (2) or (3), please be sure to observe the precautions given in those respective paragraphs.

- (2) Appropriate measures, such as fail-safe design and redundant design considering the safety design of the overall system and equipment, should be taken to ensure reliability and safety when this product is used for equipment which demands high reliability and safety in function and precision, such as ;

<ul style="list-style-type: none"> * Transportation control and safety equipment (aircraft, train, automobile etc.) * Traffic signals * Other safety equipment 	<ul style="list-style-type: none"> * Gas leakage sensor breakers * Rescue and security equipment 	
---	--	--

- (3) Please do not use this product for equipment which require extremely high reliability and safety in function and precision, such as ;

<ul style="list-style-type: none"> * Space equipment * Nuclear power control equipment 	<ul style="list-style-type: none"> * Telecommunication equipment (for trunk lines) * Medical equipment 	
--	--	--

- (4) Please contact and consult with a Sharp sales representative if there are any questions regarding interpretation of the above three paragraphs.

3. Please contact and consult with a Sharp sales representative for any questions about this product.

SHARP

GM5WA94310A Specifications

1. Application

These specifications apply to the light emitting diode device, Model No. GM5WA94310A.

[RGB 3 color-LED from AlGaInP for red and InGaN for green and blue]

This product is designed for various kinds of general indication devices.

2. Ratings and characteristics ----- Refer to Page 3 to 8.

- 2-1. Absolute maximum ratings
- 2-2. Electro-optical characteristics
- 2-3. Chromaticity rank table
- 2-4. Derating curve
- 2-5. Characteristics Diagram (TYP.)

3. External dimensions and equivalent circuit----- Refer to Page 9.

4. Reliability ----- Refer to Page 10.

- 4-1. Test items and test conditions
- 4-2. Failure criteria

5. Quality level ----- Refer to Page 11.

- 5-1. Applied standard
- 5-2. Sampling inspection
- 5-3. Inspection items and defect criteria

6. Supplements ----- Refer to Page 12 to 14.

- 6-1. Taping
- 6-2. Packing
- 6-3. Label
- 6-4. Information on environmental impact substances

7. Precautions ----- Refer to Page 15 to 16.

- 7-1. General handling
- 7-2. Soldering
- 7-3. Cleaning

REFERENCE

SHARP

2. Ratings and characteristics

2-1. Absolute maximum ratings

(Tc=25 °C)

Parameter	Symbol	Rating			Unit
		Red	Green	Blue	
Radiation Color	-	Red	Green	Blue	-
Power dissipation	P	200			mW
Forward current (Note1)	I _F	30	30	30	mA
Peak pulsed forward current (Note2)	I _{FM}	100	100	100	mA
Forward current derating factor	DC	0.60	0.60	0.60	mA/°C
	Pulse	2.00	2.00	2.00	mA/°C
Reverse voltage	V _R	5	5	5	V
Operating temperature	T _c (Note3)	-30 to +85 (Note5)			°C
Storage temperature	T _{stg}	-40 to +100			°C
Soldering temperature (Note4)	T _{sol}	295			°C

(Note 1) Each color chip has each own rating. In simultaneous operation, do not exceed total power dissipation.

(Note 2) Duty ratio $\leq 1/10$, Pulse width ≤ 0.1 ms.(Note 3) T_c (As for the measuring point, refer to Page9.)

(Note 4) Each terminal must be soldered with the soldering iron (under 30W) within 3 seconds.

Solder tip temperature: under 295°C

(Note 5) The operating current value here follows the derating curve shown in Page5.

2-2. Electro-optical characteristics

(Tc=25 °C)

Parameter	Symbol	Condition	MIN.	TYP.	MAX.	Unit
Forward voltage	Red	I _F =20 mA	1.7	2.2	2.5	V
	Green		2.8	3.3	3.7	
	Blue		2.8	3.2	3.7	
Luminous intensity (Note6)	I _V	Red : I _F =20mA Green : I _F =20mA Blue : I _F =7mA	1 200	1 800	2 500	mcd
Chromaticity coordinates (Note7)	x	Blue : I _F =7mA	(0.2750)	—	(0.3250)	
	y		(0.2435)	—	(0.3562)	
Reverse Current	Red	V _R =5V	-	-	50	μA
	Green		-	-	50	
	Blue		-	-	50	

(Note6) Measured by EG&G MODEL550(Radiometer/Photometersystem) after 20ms drive
(Tolerance : $\pm 15\%$)(Note7) Measured by Otsuka electronics MODEL MCPD-2000 after 20ms drive
(Tolerance : x,y: ± 0.02)Data shown here are classified by above mentioned conditions, and are not guaranteed data.
Refer to Page4, for chromaticity rank table.

REFERENCE



2-3. Chromaticity coordinates rank table

REFERENCE

Rank	Chromaticity coordinates (x, y)								Conditions
	Point 1		Point 2		Point 3		Point 4		
	x	y	x	y	x	y	x	y	
a	0.2875	0.3466	0.3000	0.3498	0.2875	0.3216	0.3000	0.3248	(T _c =25 °C) Red: I _F =20mA Green: I _F =20mA Blue: I _F =7mA
b	0.3000	0.3498	0.3125	0.3530	0.3000	0.3248	0.3125	0.3280	
c	0.3125	0.3530	0.3250	0.3562	0.3125	0.3280	0.3250	0.3312	
d	0.2750	0.3185	0.2875	0.3216	0.2750	0.2935	0.2875	0.2966	
e	0.2875	0.3216	0.3000	0.3248	0.2875	0.2966	0.3000	0.2998	
f	0.3000	0.3248	0.3125	0.3280	0.3000	0.2998	0.3125	0.3030	
g	0.3125	0.3280	0.3250	0.3312	0.3125	0.3030	0.3250	0.3062	
h	0.2750	0.2935	0.2875	0.2966	0.2750	0.2685	0.2875	0.2716	
i	0.2875	0.2966	0.3000	0.2998	0.2875	0.2716	0.3000	0.2748	
k	0.3000	0.2998	0.3125	0.3030	0.3000	0.2748	0.3125	0.2780	
m	0.3125	0.3030	0.3250	0.3062	0.3125	0.2780	0.3250	0.2812	
n	0.2750	0.2685	0.2875	0.2716	0.2750	0.2435	0.2875	0.2466	
p	0.2875	0.2716	0.3000	0.2748	0.2875	0.2466	0.3000	0.2498	
r	0.3000	0.2748	0.3125	0.2780	0.3000	0.2498	0.3125	0.2530	

(Tolerance : ±0.02)

(Note1) Chromaticity ranks are classified under the conditions shown above table, and they are not guaranteed values.

(Note2) Quantity of each rank is decided by Sharp.

(Note3) In simultaneous operation, adjust the current of each color within specified rating of power dissipation.

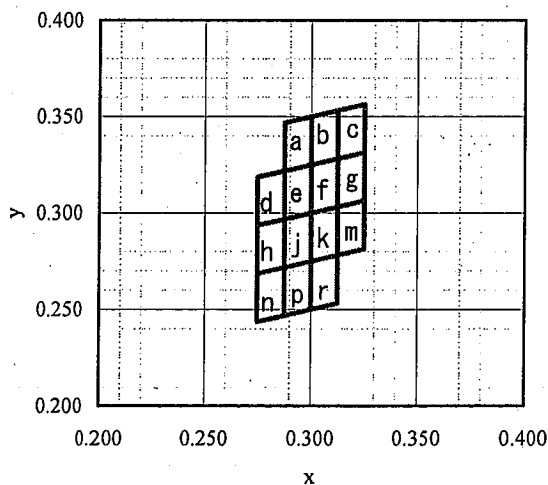

Chromaticity diagram



2-4. Derating curve

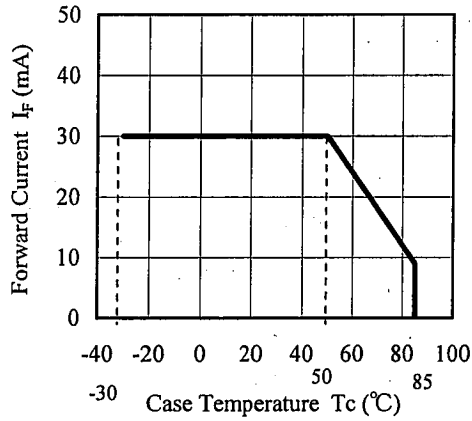

Forward Current Derating Curve

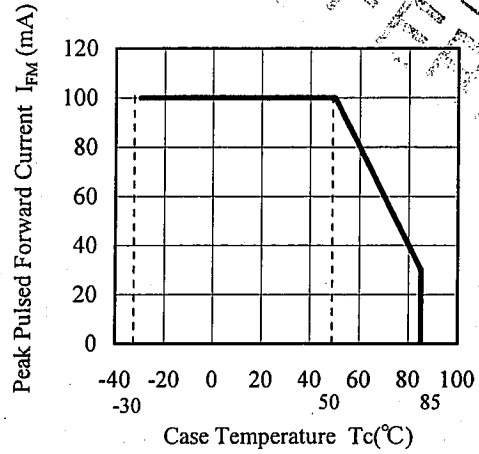

Peak Pulsed Forward Current Derating Curve
Duty ratio 1/10, Pulse width 0.1ms

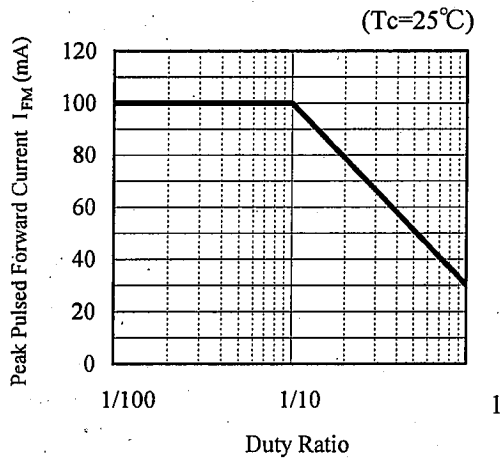

Peak Pulsed Forward Current vs. Duty Ratio
Pulse width 0.1ms

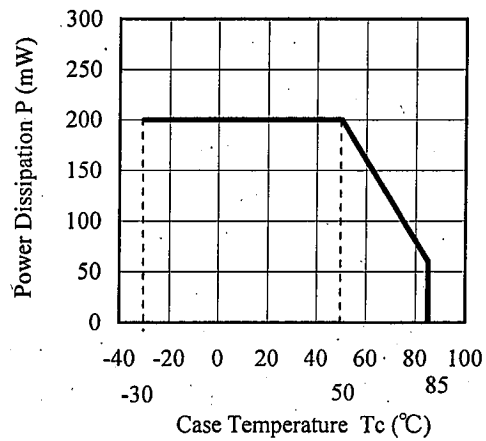

Power Dissipation Derating Curve

(Note1) The graphs of 'Forward Current Derating Curve', 'Peak Pulsed Forward Current Derating Curve', and 'Peak Pulsed Forward Current vs. Duty Ratio' apply to the case of 1 chip-operation.

(Note2) Power Dissipation Derating Curve is applied to 3 chip-operations; however each color-chip has prior limitation of Forward Current Derating Curve over this.

SHARP

2-5. Characteristics Diagram (TYP.)

2-5-1. Red

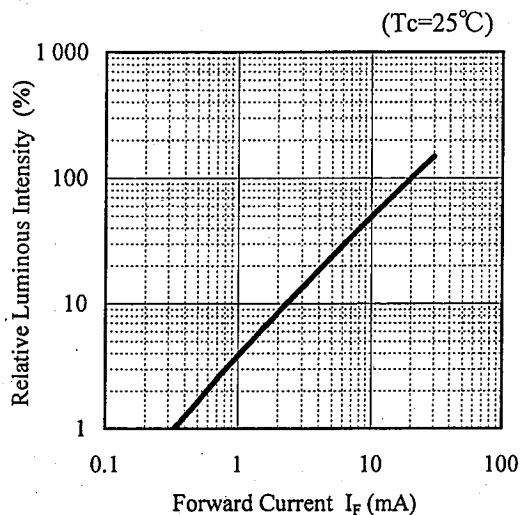

Relative Luminous Intensity vs. Forward Current

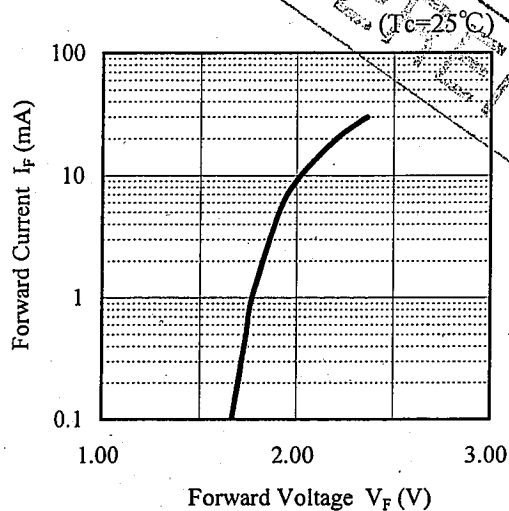

Forward Current vs. Forward Voltage

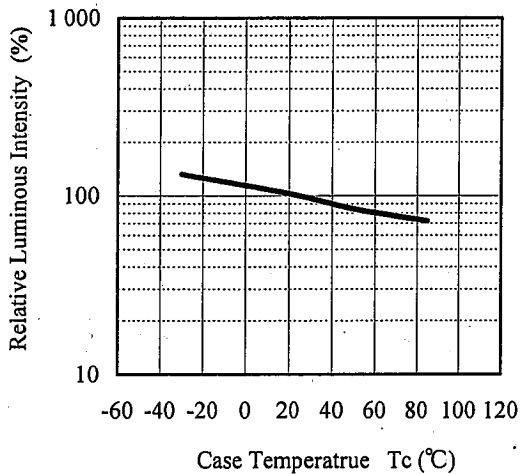

Relative Luminous Intensity vs. Case Temperature

(Note) Data shown here is for reference purpose only. (Not guaranteed values)



2-5-2. Green

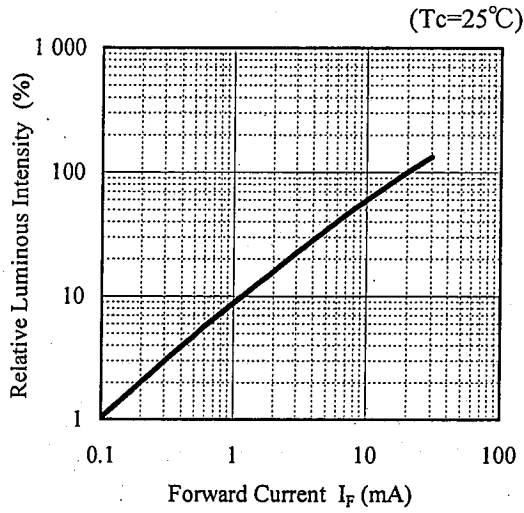

Relative luminous intensity vs. Forward Current

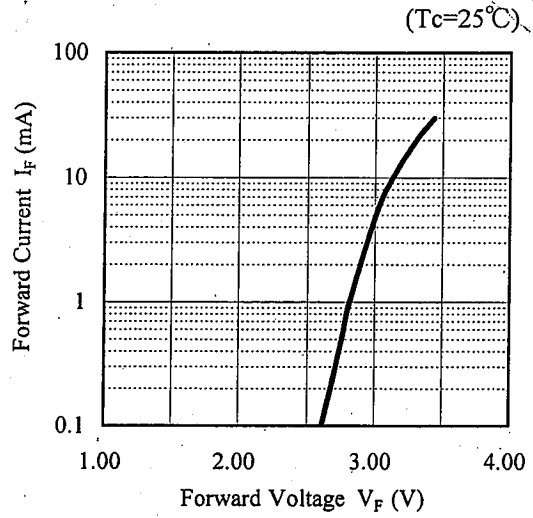

Forward Current vs. Forward Voltage

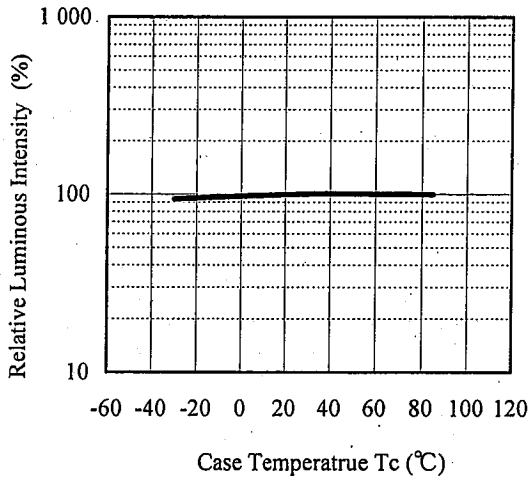

Relative Luminous Intensity vs. Case Temperature

(Note) Data shown here is for reference purpose only. (Not guaranteed values)

REFERENCE

SHARP

2-5-3. Blue

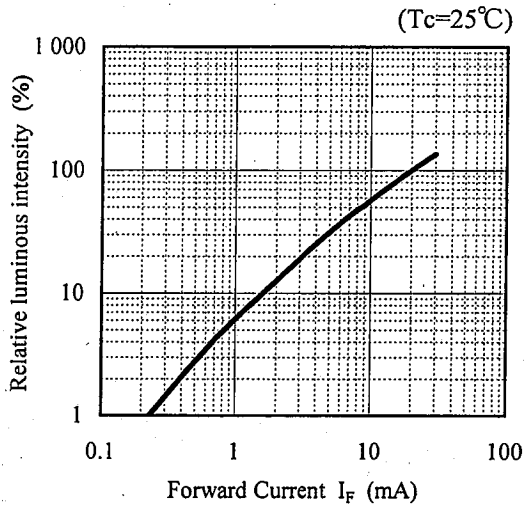

Relative Luminous Intensity vs. Forward Current

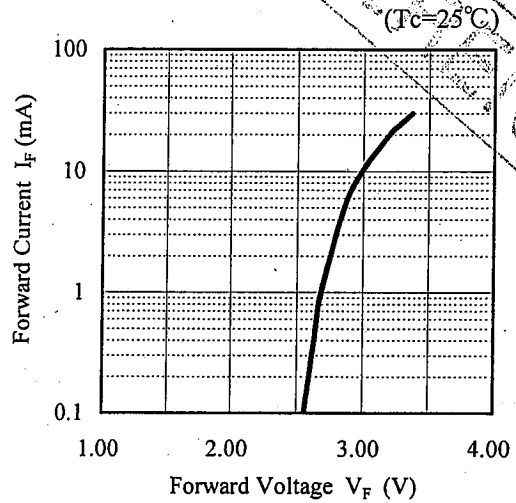

Forward Current vs. Forward Voltage

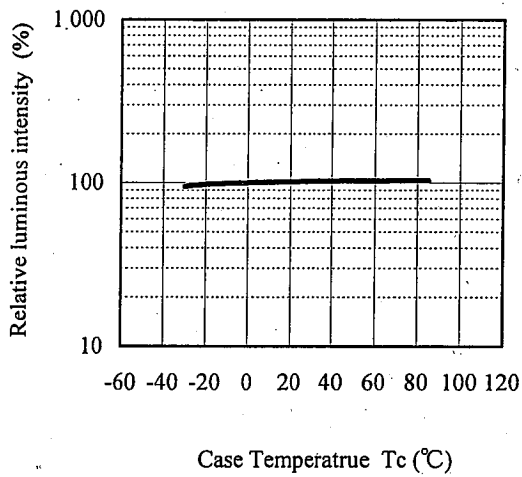

Relative Luminous Intensity vs. Case temperature

(Note) Data shown here is for reference purpose only. (Not guaranteed values)

SHARP

3. External dimensions and equivalent circuit

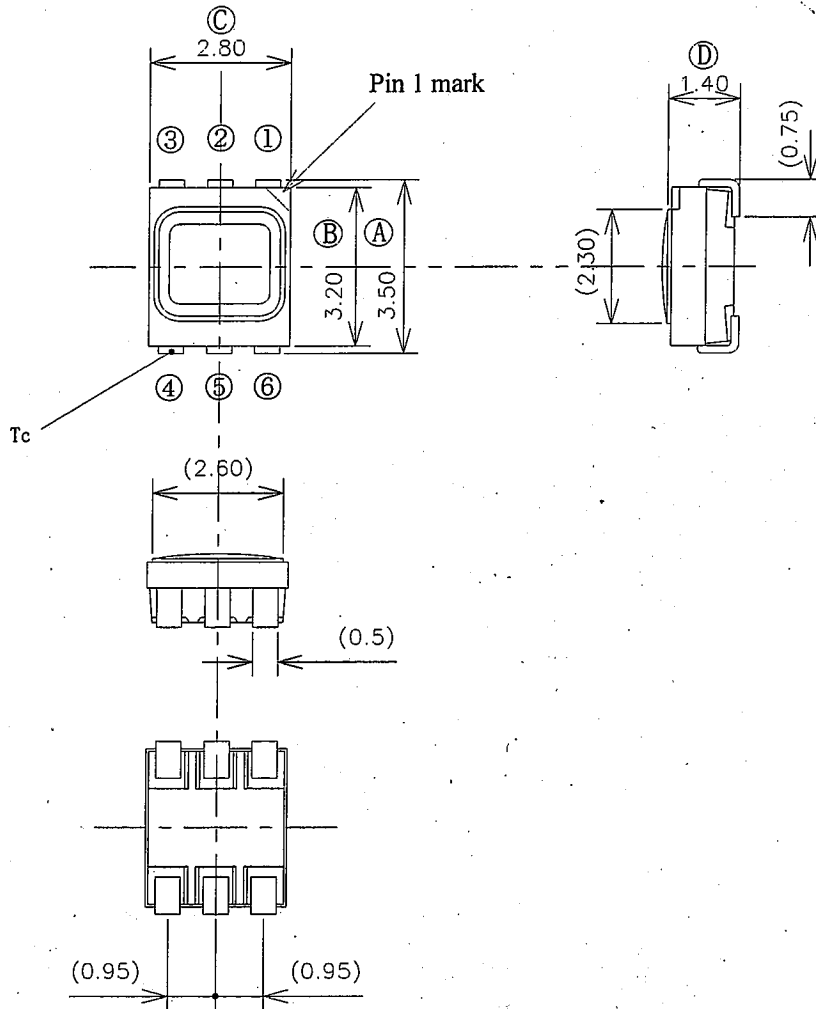

REFERENCE

(Notes)

1. Unspecified tolerance to be $\pm 0.3\text{mm}$
2. Value inside parenthesis is a reference value.
3. Tc: Measuring point of case temperature
4. Resin color of the package: White

Pin arrangement

No.	Name
①	Blue Anode
②	Red Anode
③	Green Anode
④	Green Cathode
⑤	Red Cathode
⑥	Blue Cathode

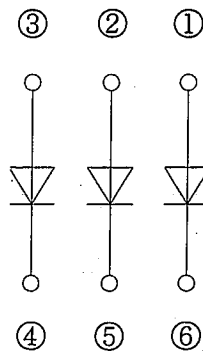

Equivalent circuit

Unit	Material	Finish	Drawing No.
mm	Frame: Copper alloy Package: Nylon and Silicone resin	Frame: PdAu plating	51912008

SHARP

REFERENCE

4. Reliability

The reliability of products shall be satisfied with items listed below.

4-1. Test items and test conditions

Confidence level: 90%

No.	Test items	Test conditions	Samples n	Defective C	LTPD (%)
1	Temperature cycle	-40 °C (30 min) to + 100 °C (30 min), 30 times	22	0	10
2	Temperature humidity storage	Tstg = +60 °C, RH = 90 %, time = 1 000 h	22	0	10
3	High temperature storage	Tstg = 100 °C, time = 1 000 h	22	0	10
4	Low temperature storage	Tstg = -40°C, time = 1 000 h	22	0	10
5	Steady state operating life	Tc = +50 °C, I _F = 20 mA (For each chip), time = 1 000 h In mixed color operation	22	0	10
6	Shock	Acceleration: 15 000 m/s ² , Pulse width: 0.5 ms, Tc = +25°C Direction: 3 directions (X, Y and Z) 3 trials in each direction	11	0	20
7	Vibration	Frequency: 100 to 2 000 Hz for 4 minutes per trial Acceleration: 200 m/s ² Direction: 3 directions (X, Y and Z) 4 trials in each direction, Tc = +25°C	11	0	20
8	Resistance to Soldering heat	Refer to Page15, as for soldering conditions. Twice	11	0	20
9	Solderability	Solder/ Flux: M705/ ESR250 (SENJU METAL INDUSTRY CO., LTD) Solder temperature: 240±5 °C Dip time: 5±1 s	11	0	20

4-2. Failure criteria

No.	Parameter	Symbol	Failure criteria
1	Forward voltage	V _F	V _F > U.S.L × 1.2
2	Reverse current	I _R	I _R > U.S.L × 2.0
3	Luminous intensity	I _V	I _V < Initial value × 0.5, I _V > Initial value × 2.0

(Note1) Measuring conditions accord with the specification.

(Note2) U.S.L. stands for Upper Specification Limit.

(Note3) Solderability failure criterion: NG if less than 90% of the solderability judgment area is not soldered.

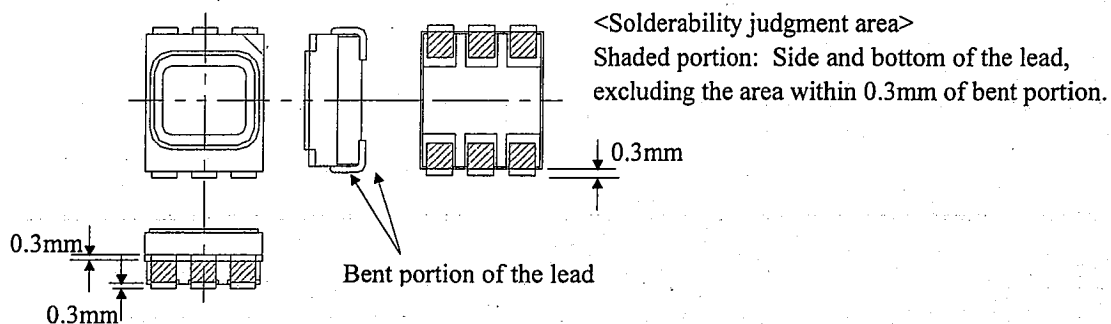

SHARP

5. Quality level

5-1. Applied standard
ISO2859-1

5-2. Sampling inspection
A single normal sampling plan, level S-4.

5-3. Inspection items and defect criteria

No.	Inspection items	Defect criteria	Defect	AQL
1	Radiation color	Different from the specified color	Major defect	0.1 %
2	Taping	Not conforming to the orientation shown in the specifications		
3	Electro-optical characteristics	Not conforming to specified value in Page3, for V_F , I_R , and I_V .	Minor defect	0.4%
4	External dimensions	Not conforming to specified dimensions mentioned in Page9. (From A to D)		
5	Appearance	0.4mm or more in diameter of bubbles, foreign materials, and scratches Resin burr over dimension tolerance 0.4mm or more of resin or terminal chipping Thread trash beyond the width 0.2mm and the length 2.5mm		

REFERENCE

SHARP

6. Supplement

6-1. Taping

6-1-1. Shape and dimension of tape (Ref.)

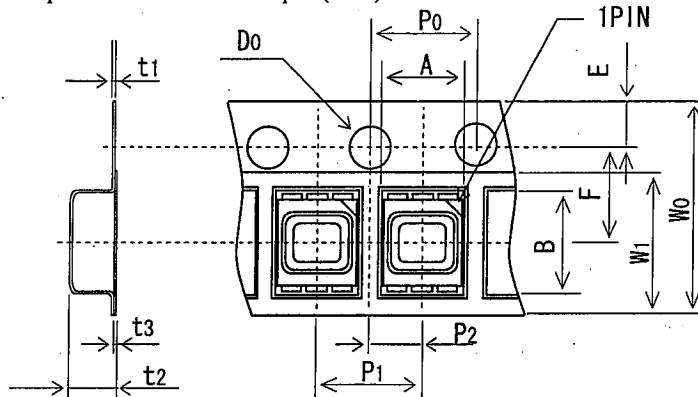

REFERENCE

Parameters		Symbols	Dimensions [mm](TYP.)	Remarks	
Concave square hole for part insertion	Vertical	A	2.9	Dimension excludes corner R at inside bottom	
	Horizontal	B	3.8		
	Pitch	P ₁	4.0		
Round sprocket hole	Diameter	D ₀	1.5		
	Pitch	P ₀	4.0	Accumulated error ±0.5mm/10pitch	
	Position	E	1.75	Distance between tape edge and hole center	
Center to center dimension	Vert. dire	P ₂	2.0	Center line of the concave square hole and round sprocket hole	
	Hori. dire	F	3.5		
Cover tape	Width	W ₁	5.4		
	Thickness	t ₃	0.1		
Carrier tape	Width	W ₀	8.0		
	Thickness	t ₁	0.2		
Thickness of the entire unit			t ₂	2.1	With cover tape and carrier tape combined

6-1-2. Shape and dimension of reel (Ref.)

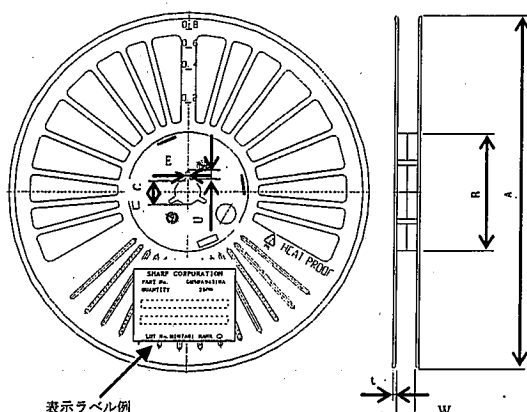

Parameter		Symbol	Dimension [mm]	Remarks	
Flange	Diameter	A	180		
	Thickness	t	1.3		
	Inner space direction	W	9.5	Dimension of shaft core	
Hub	External diameter	B	60		
	Spindle hole diameter	C	13		
	Key slit	Width	E	2.0	
		Depth	U	4	
Notation for model No. etc.			Labeling on the side of the flange. (Model No., quantity, lot No.)		

Material: on reel

SHARP

6-1-3. Taping specification

(1) Leader tape: JIS C0806 standard compliant

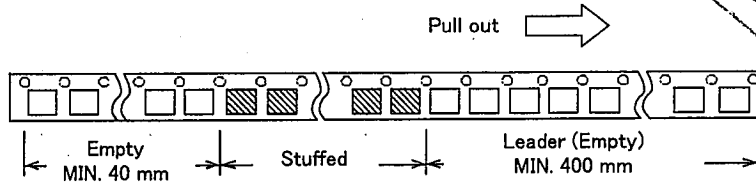

(2) Cover tape strength against peeling: $F = 0.1 \sim 1.0N (\theta = 10^\circ \text{ or less})$

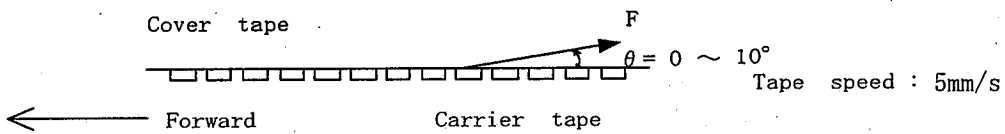

(3) Tape strength against bending:

The radius of bending curvature should be more than 30mm.

If it is bent at under 30mm, the cover may peel off.

(4) Jointing of tape: There should not be joint of cover tape or carrier tape.

(5) Quantity: Average 2 500 pcs. per reel

(6) Product mass: 25 mg (One product/ typ.)

- (7) Others:
- ① There is no continuous empty pockets.
 - ② The quantity of the products lacking should be less than 0.1% of total product quantity.
 - ③ Products should be easily taken out.
 - ④ Products should not be attached to the cover tape when it peeled off.

6-2. Packing

6-2-1. Moisture proof packing

In order to avoid the absorption of humidity while transport and storage, the devices are packed in moisture proof aluminum bags.

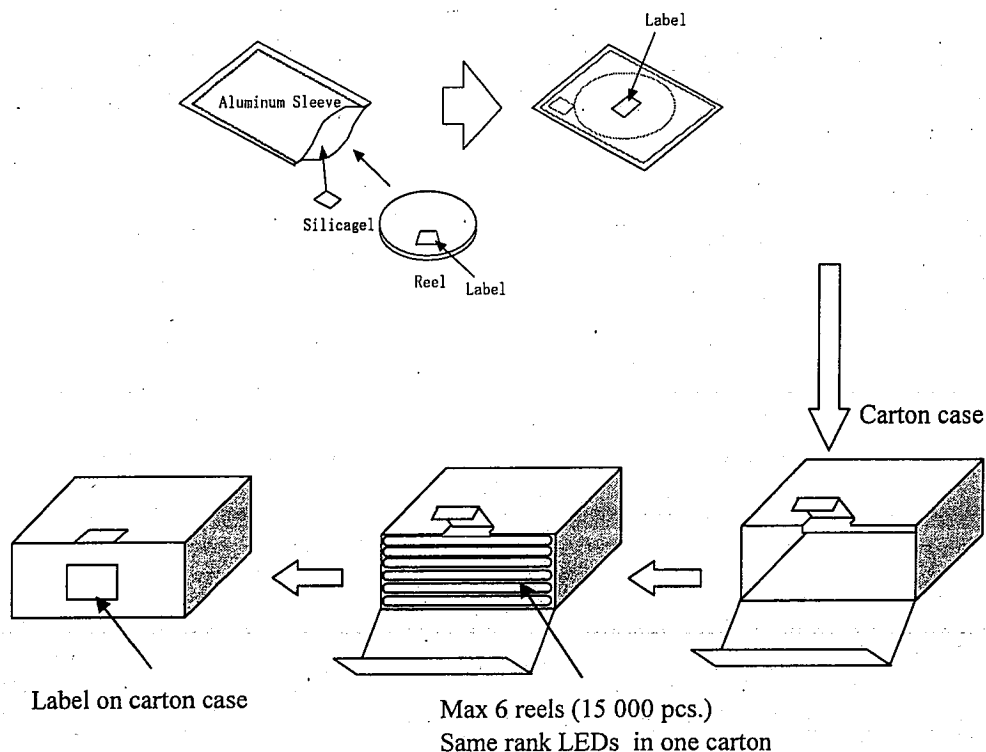

SHARP

6-2-2. Storage conditions

Temperature: 5 to 30°C, Relative Humidity: 60% or less

6-2-3. Precautions after opening aluminum bags

- (1) Please keep the devices under the following conditions after opened, and give the soldering process within 3 days.

Temperature : 5°C to 30°C Relative humidity: 60% or less

- (2) In case that the devices are not used for a long time after opened, the storage in a dry box would be recommended.

It is also recommended to repack the devices with a desiccative by the sealer and keep them under the same storage conditions as 6-2-2.

- (3) Please give the following baking treatment before soldering to the product once opened and stored. Baking time: only once

Recommended conditions:

- ① In taping : 95°C to 100°C, 16 to 24 hours
② In individual (on PCB or metallic tray):

Temperature: 100 °C to 120 °C , Time: more than 12 to 15hours

Deformation of the reels might be caused if the baking process was given under the stressed condition like piling up the products.

Please confirm that the product is cooled to the room temperature after the baking treatment.

6-3. Label

SHARP CORPORATION	
PART No.	GM5WA94310A
QUANTITY	2500
[Bar code area]	
[Bar code area]	
LOT No.MI07A01 RANK O (EIAJ C-3) MADE IN PHILIPPINES	

← Model number

← Product quantity

← EIAJ C-3 Bar code

← EIAJ C-3 Bar code

← Indication example of LOT number and rank

← Indication example of production country

<LOT Number>

M I 07 A 01

① ② ③ ④

① Production plant code (to be indicated alphabetically)

② Year of production (the last two figures of the year)

③ Month of production

(to be indicated alphabetically with January corresponding to A)

④ Date of production (01~31)

<Rank>

Rank O : Chromaticity rank

(Refer to Page4, for chromaticity rank table.)

6-4. Information on environmental impact substances

6-4-1. RoHS compliant product

This product is manufactured in accordance with RoHS directive.
(Applied to the products manufactured in and after April of 2001.)

6-4-2. Ozone Depleting Substances

- (1) This product doesn't contain the following Ozone Depleting Substances.
(2) This product doesn't have a production line whose process requires the following Ozone Depleting Substances.

Restricted substances: CFCs, Halones, CCl₄, 1, 1, 1-Trichloroethane (Methyl chloroform)

SHARP

REFERENCE

7. Precautions

7-1. General handling

- ① In designing a circuit, please make sure not to give any reverse voltage to the products.
- ② Since the products are very small, they are easily damaged by external stress.
Please avoid applying stress to them after the assemblies.
- ③ Staring at the LED light directly and continuously, when operated at high luminous intensity, may result in hurting your eyes.
- ④ This product can be damaged by static electricity or surge voltage. Please equip yourself with a wrist band or anti-electricity gloves in handling the products.
Also, make sure that all the devices and equipments must be grounded.
- ⑤ Materials with high thermal conductivity is used in this product in order to allow generated heat to escape effectively out of the LED. Avoid locating other heat sources (ex. resistance, etc.) near the LED on the circuit board. Those heat sources will damage the devices.
The circuit board should be designed in a way that other heat sources are located away from the products. Please design the circuit board so that case temperature is always kept under 85°C including the self-heating (when products operated).
- ⑥ Since dust on the surface of the radiation part is hard to take off and may cause to weaken luminous intensity level, please handle the products in a clean, non-dusty condition. Also, the products can be easily damaged, if collets of mounting machine apply excessive stress to the resin parts. Therefore, please check and study your mounting conditions in handling the products.
- ⑦ Please pay attention not to apply any external stress or force to resin after mounting as well.
- ⑧ The products are not designed for the use under any of the following conditions. Please verify their performance and reliability well enough if you use under any of the following conditions;
 - (1) In a place with a lot of moisture, dew condensation, briny air, and corrosive gas (Cl, H₂S, NH₃, SO₂, NO_x, etc.).
 - (2) Under the direct sunlight, outdoor exposure, and in a dusty place.
 - (3) In water, oil, medical fluid, and organic solvent.

7-2. Soldering

7-2-1. Reflow

- (1) It is not recommended to exceed the soldering temperature and time shown below.
Caused by substrate bend or the other mechanical stress during reflow soldering may happen gold wire disconnection etc. Therefore please check and study your solder reflow machine's best condition.
- (2) In case of 2 times reflow process, 2nd reflow process must be performed as soon as possible after the 1st reflow.
(Storage in a dry box after the first reflow is recommended.)
- (3) Temperature profile

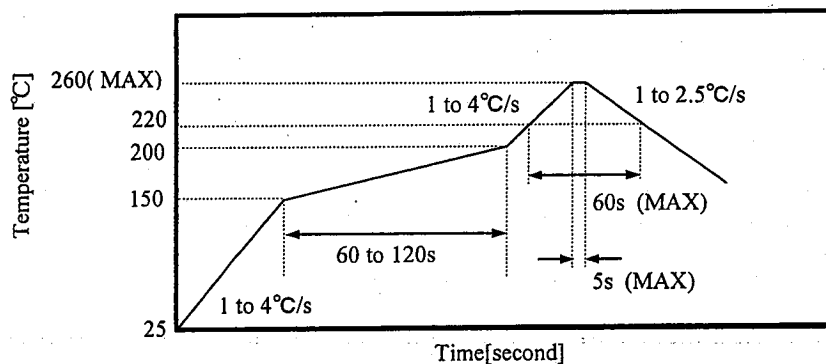

SHARP

In order to maintain the products quality, it is recommended that the peak temperature should be lower, and cool down should be taken longer, and that the gradient of cool down temperature should be as low as possible. Moreover, since the thermal conduction to the products depends on the specification of the reflow machine, and the size and layout of the PCBs. Please verify your solder conditions carefully.

(4) Recommended solder pad design

Solderability depends on the reflow condition, solder paste and materials of the PCBs etc.
Please check and study actual solder ability before usage.

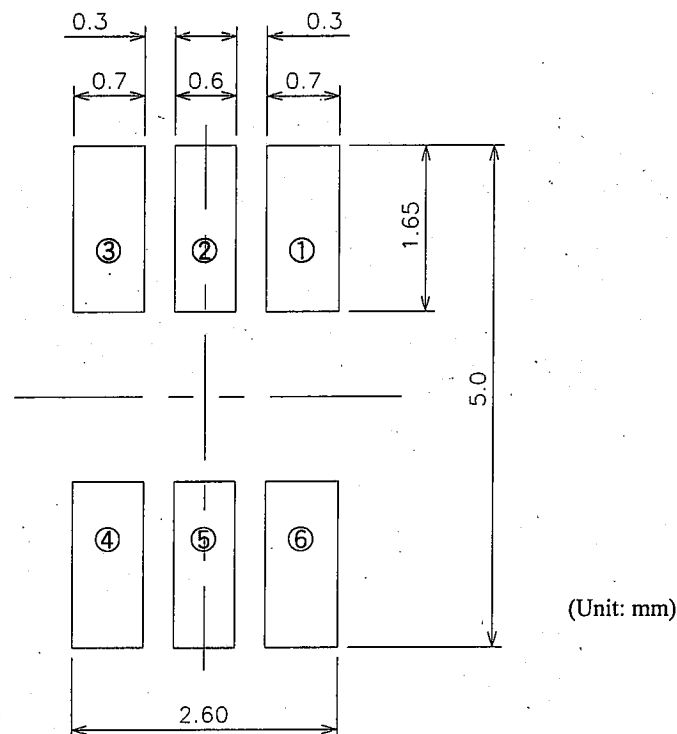

(5) Precaution for PCB backside dip process

Please check and study your conditions carefully in giving the dip process on the backside of the PCBs, since the warped boards caused by heat and heat itself affect the inside of the package. It is recommended to give the reflow process after dip process. Though it is also available to give the reflow process before the dip process, the interval of the two processes should be as short as possible.

7-3. Cleaning

Avoid cleaning the PCBs, since packages and resins would be eroded by cleaning.
Please use the soldering paste without need of cleaning. Avoid ultrasonic cleaning.